

# MACK STYLE 50 GALLON 25" DIAMETER

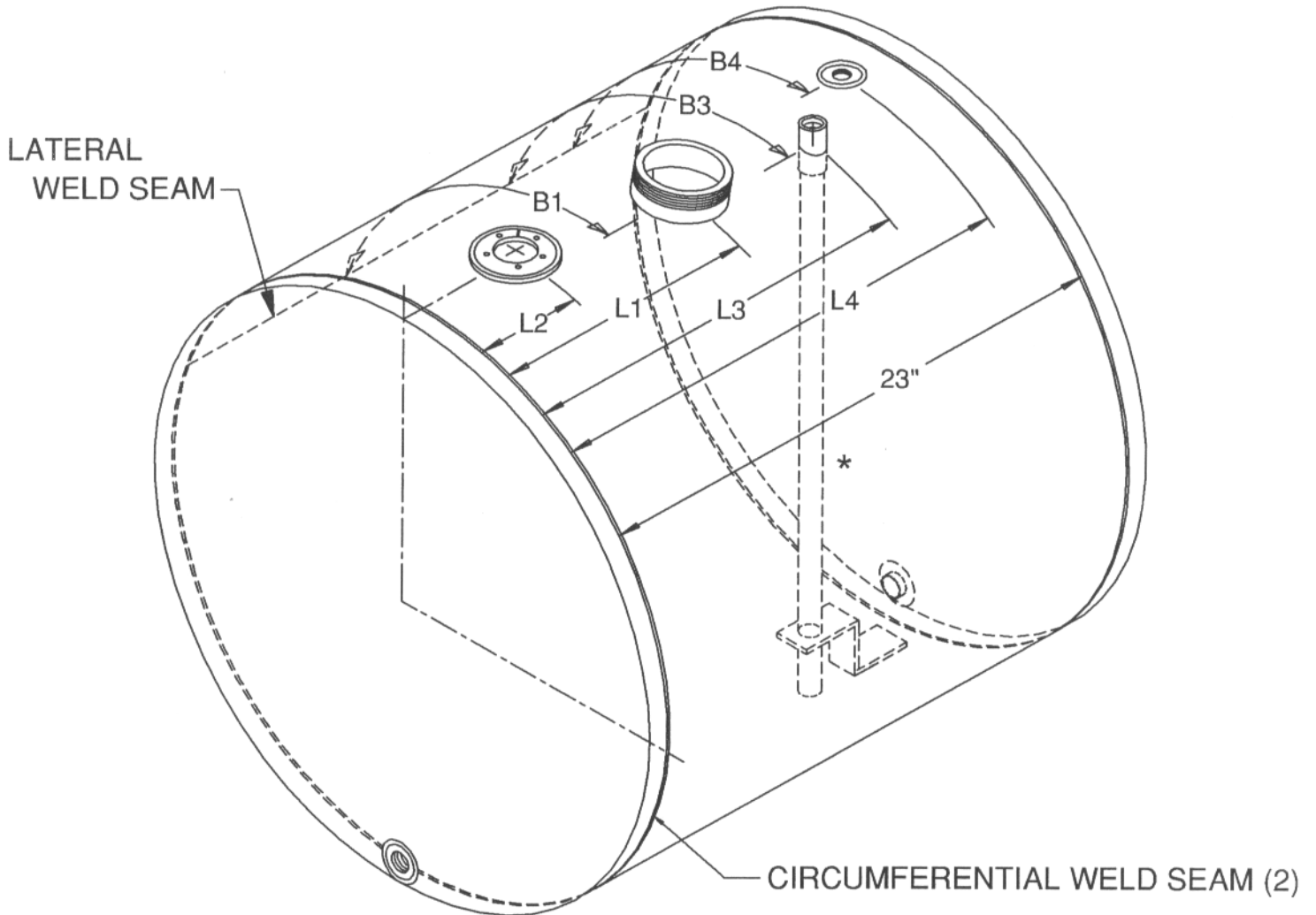

ALL MEASUREMENTS ARE TAKEN FROM WELD SEAMS, EITHER CIRCUMFERENTIAL OR LATERAL.

FILL NECK LOCATION L1 X B1 \_\_\_\_\_ STANDARD SIZE IS 3" NPT

FUEL GAUGE LOCATION L2 \_\_\_\_\_

VENT LOCATION L4 X B4 \_\_\_\_\_ STANDARD SIZE IS 3/8" NPT

DRAW PIPE LOCATION L3 X B3 \_\_\_\_\_ STANDARD SIZE IS 1/2" NPT

CROSSOVER LOCATION \_\_\_\_\_ STANDARD LOCATION IS ON EITHER HEAD

ALL TANKS COME WITHOUT A FILL CAP UNLESS OTHERWISE SPECIFIED.

NOTE: PLEASE FILL IN ALL "L" AND "B" DIMENSIONS, AND NOTE ANY PREFERENCES IN FITTINGS SIZES. THEN FAX A COPY TO *ALUMITANK* AT 262 - 736 - 4203. IF YOU HAVE ANY QUESTIONS, PLEASE CALL 800 - 652 - 6630.

\*DRAW PIPE SHOWN OUT OF POSITION FOR ILLUSTRATION PURPOSES.