

#123

No Parts

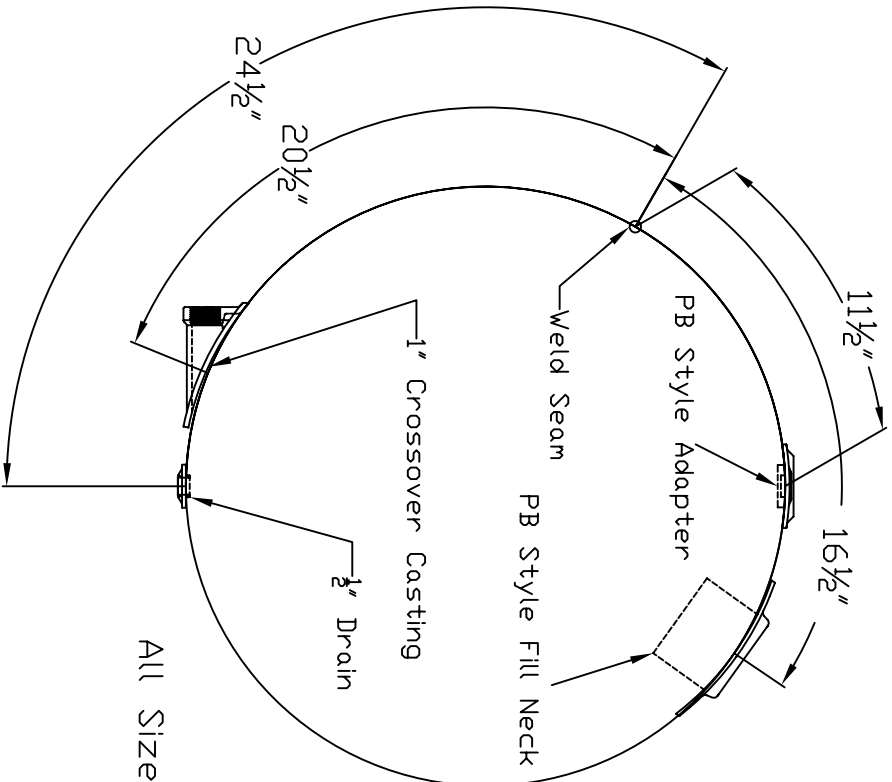

All Sizes are NPT unless otherwise noted.

Peterbilt Style

POLISHED

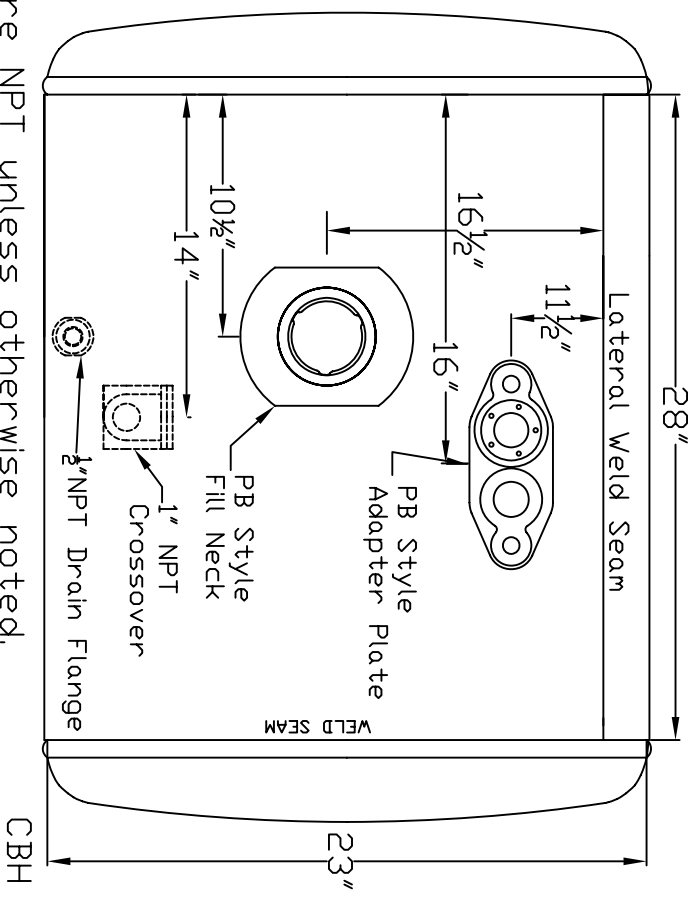

Signature: _____

Date: _____

No Parts

In an effort to ensure accuracy, please review your drawing dimensions and fitting sizes for possible errors or omissions. Call with any corrections before signing this drawing.